

Data Sheet



Article number: 0118010

Description: Retaining ring H 3

Measures

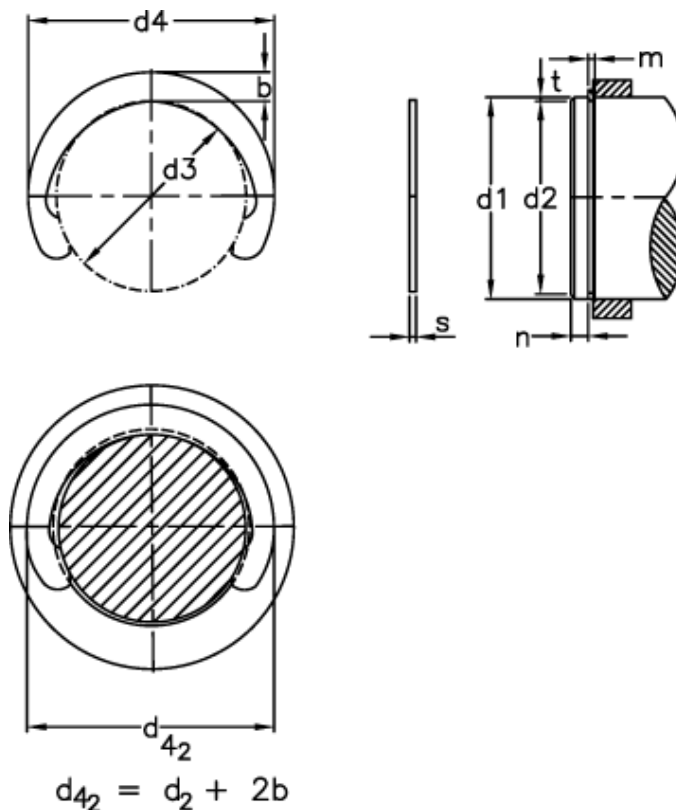

b	= 0.90	FRg kN	= 0.4	t	= 0.35
d1	= 3	FR kN	= 0.50	tol	= -0.07
d2	= 2.3	g	= 0.40	tol	= 0.06
d3	= 2.18	Gripper	= GRH 3	tol	= -0.05
d4	= 3.98	m min	= 0.44	Weight kg/1000	= 0.02
d4 2	= 4.1	n abl x 1000	= 95		
Description	= H 3,0	Nominal drive	= 1.0		
FN kN	= 0.24	s	= 0.40		